

# 9. BLOCK DIAGRAM

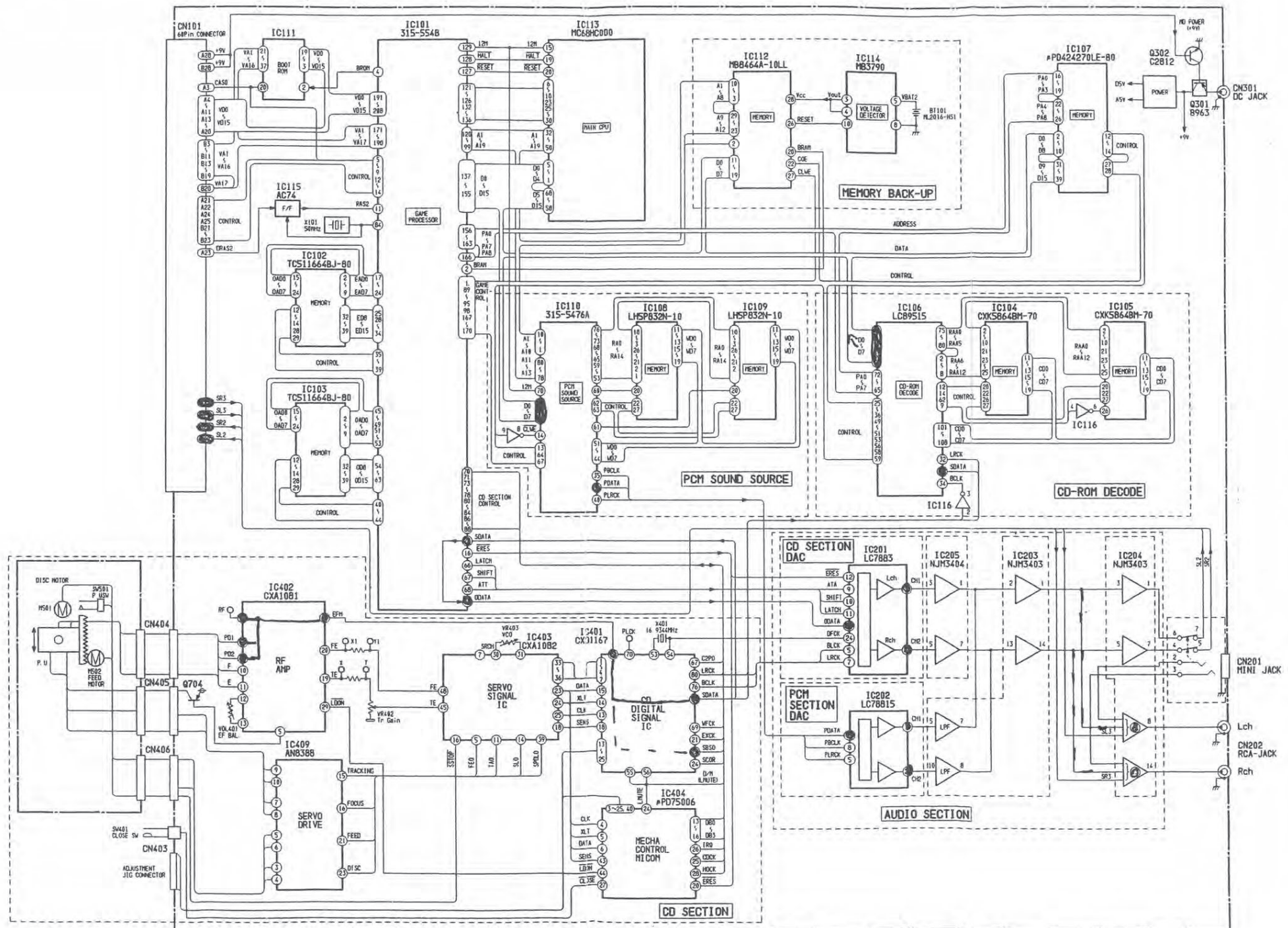

# 10. SCHEMATIC DIAGRAM

## 10-1. Schematic Diagram-1

E

D

C

B

A

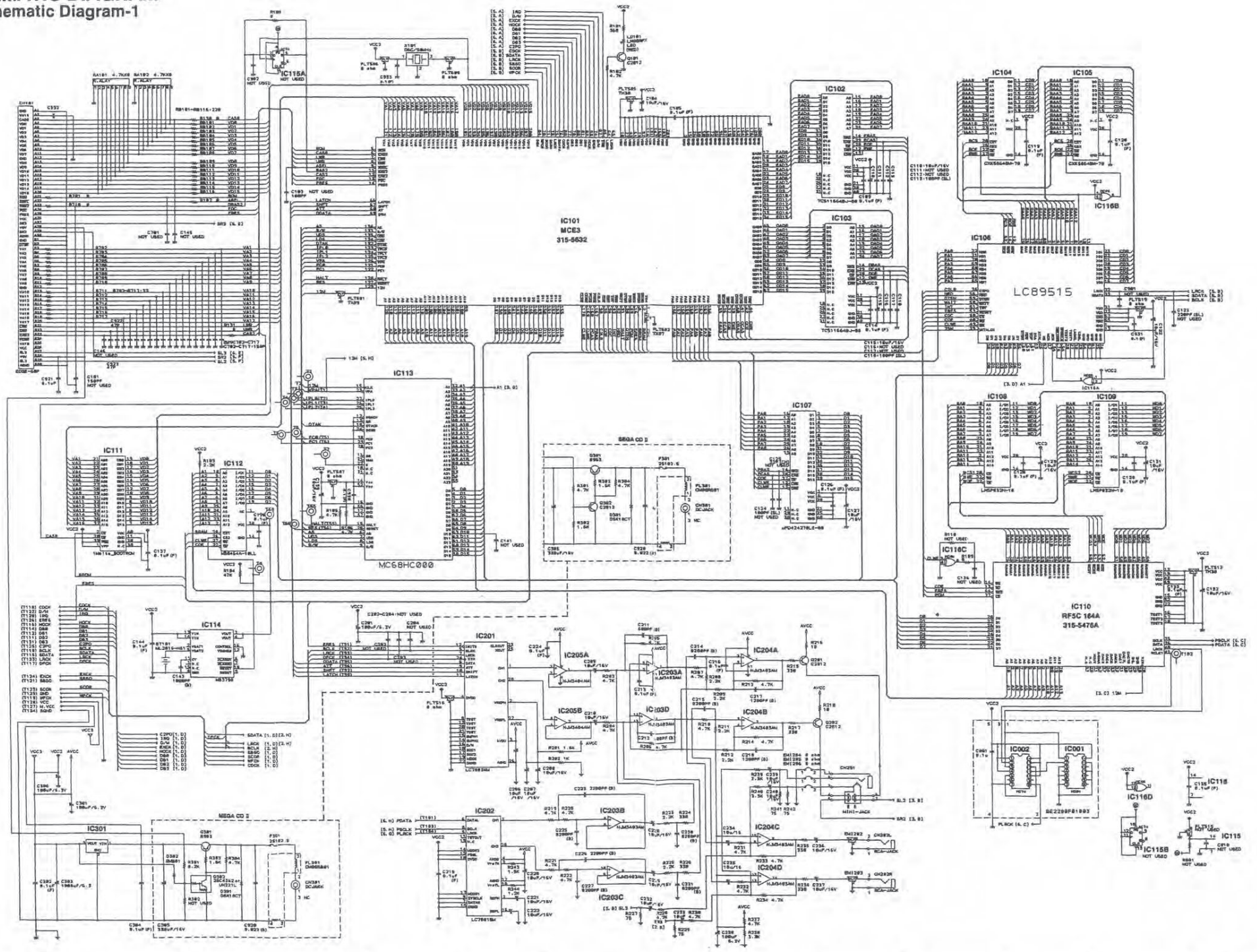

10-1. Schematic Diagram-2

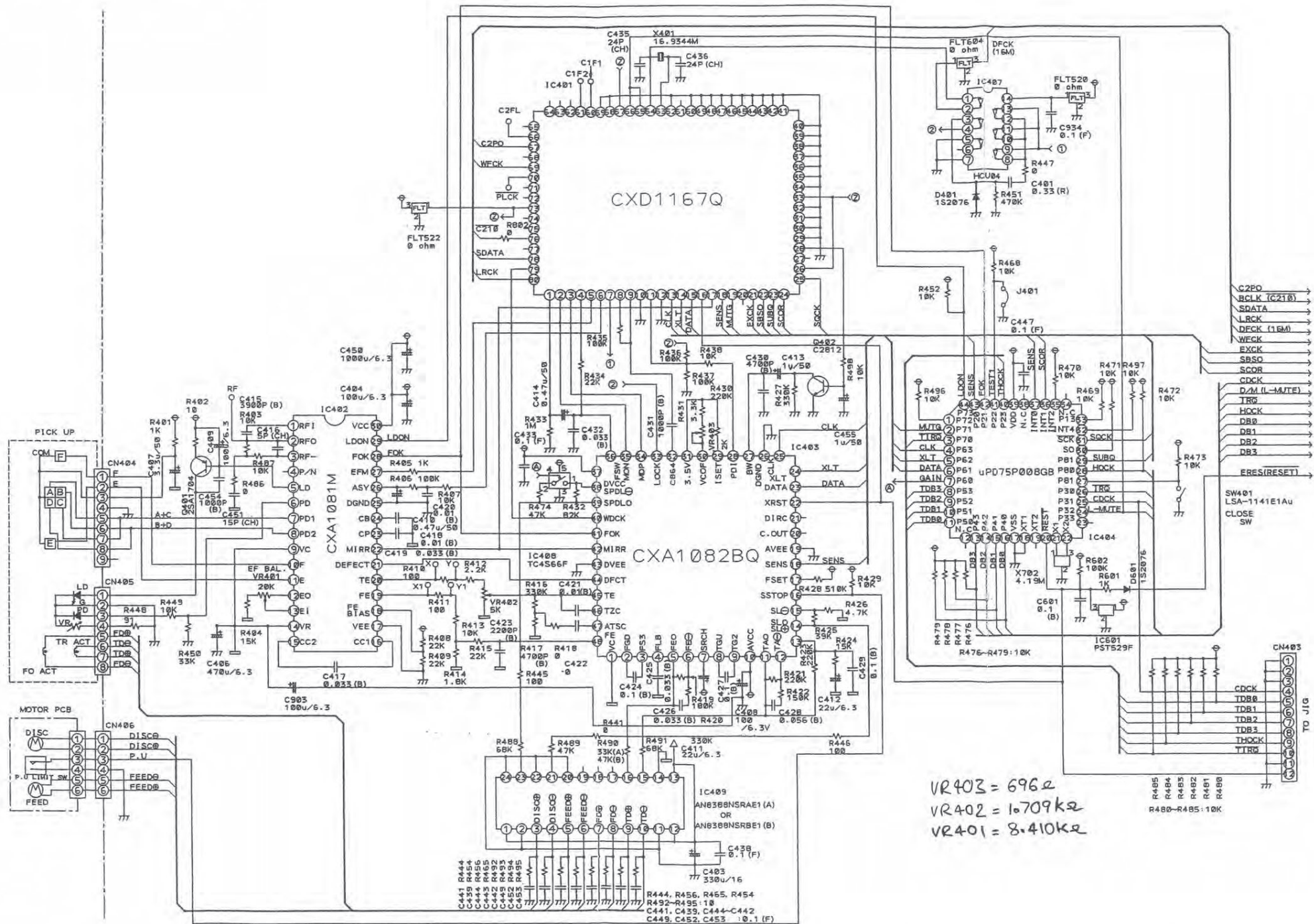

VR403 = 696Ω  
 VR402 = 1.709kΩ  
 VR401 = 8.410kΩ

R480-R485: 10K

# 11. CIRCUIT BOARD DIAGRAM

## 11-1. Main Circuit Board(Top View)

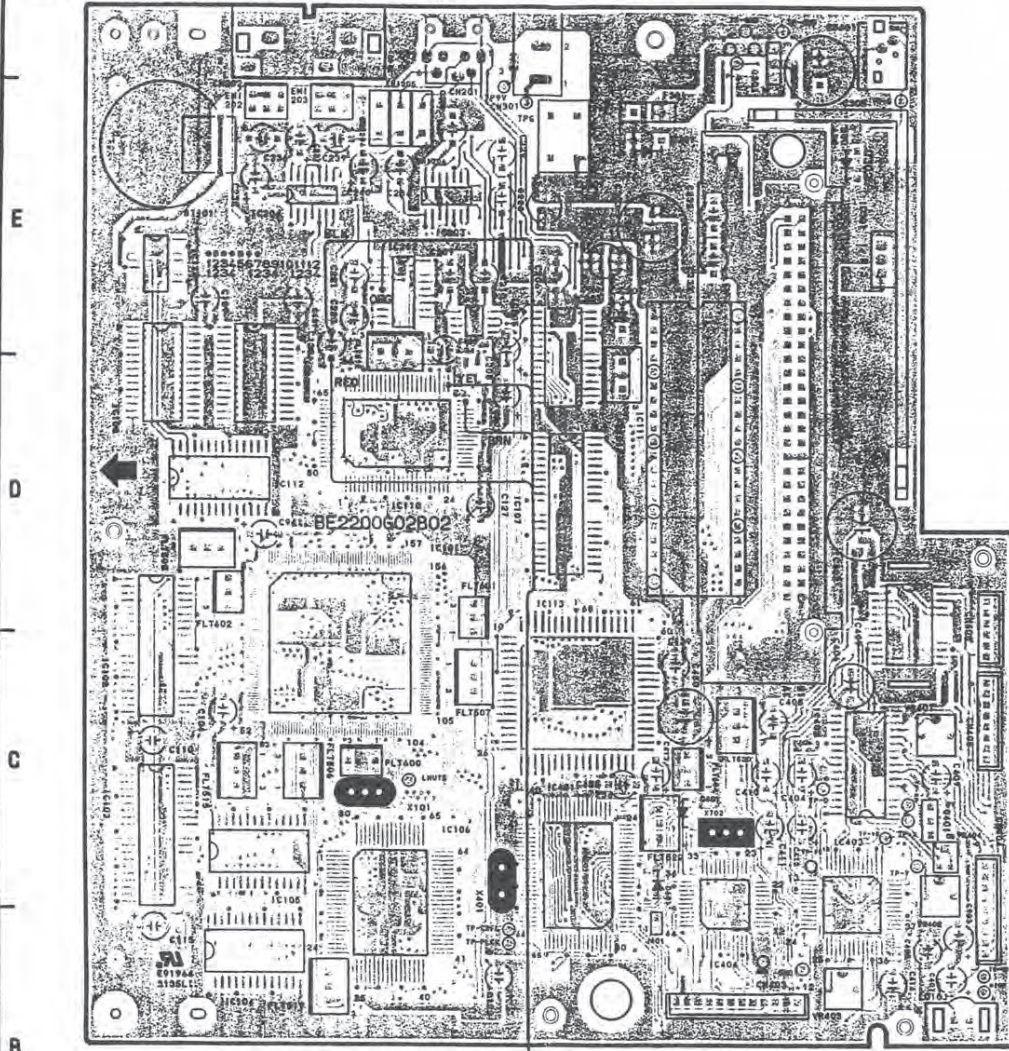

## 11-2. Main Circuit Board(Bottom View)

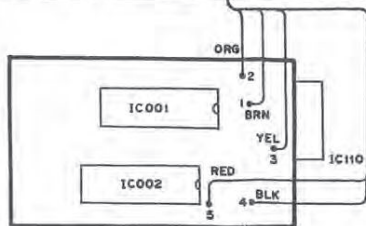
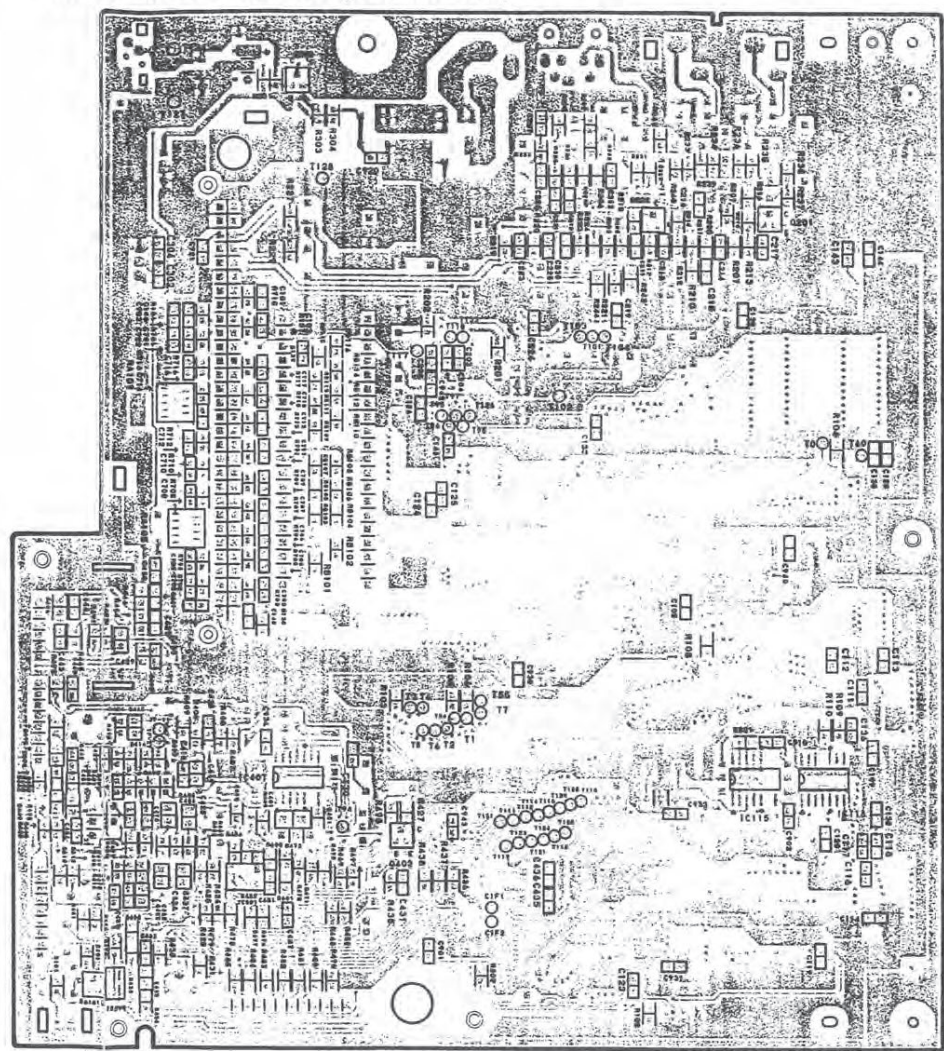

## 12. PARTS SPECIFICATIONS

IC001 HEX INVERTER

IC74HC04

■ Top View & Pin Layout

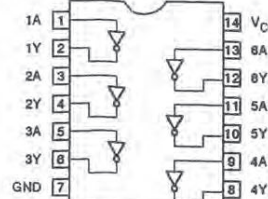

IC002 DUAL D-TYPE FLIP FLOP

IC74HC74

■ Top View & Pin Layout

